

Pressure limiter ÜB...A4 and NB...A4

5.06

DUNGS[®]
Combustion Controls



Technical description

The pressure limiters ÜB...A4 and NB...A4 are adjustable pressure switches as per EN 1854 for automatic burner controls.

They are suitable for switching a circuit on, off or over on changes in actual pressure value relative to the set reference value.

The reference value (switching point) is adjusted on a setting wheel provided with a scale. Test nipple integrated in metal housing as standard.

Application

Pressure monitoring in firing, ventilation and air-conditioning systems. Suitable for gases of families 1,2,3 and other neutral gaseous media.

Approvals

EC type testing certificate as per:

- EC-Gas Appliances Regulation
- EC-Pressure Equipment Directive

Approvals in other important gas-consuming countries. Special designs for the North American market with U_L, FM and CSA registrations.

Functional description

Single-acting pressure limiter in pressure range.

The pressure limiters work without using any auxiliary power.

ÜB...A4, NB...A4 pressure limiters

The control unit responds to pressure. Interlock is performed when the set reference value is exceeded or undershot.

The "Locked" switching state is indicated by a glow lamp.

Restart is only possible by activating the reset button on the setting wheel of the pressure limiter after the operating pressure is attained.

ÜB...A4: Switches and locks when the set pressure is exceeded.

NB...A4: Switches and locks when the set pressure is undershot.

ÜB...A4 switching function

As pressure rises

2 NO closes, 1 NC opens
Glow lamp ON, locked.

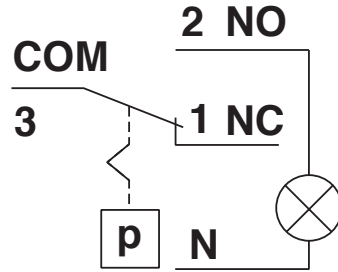

NB...A4 switching function

As pressure falls

2 NO opens, 1 NC closes
Glow lamp ON, locked.

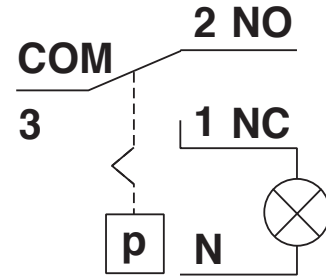

Operating state

Specifications

Max. operating pressure	NB, ÜB 50-150 A4 NB, ÜB 500 A4	500 mbar (50 kPa) 600 mbar (60 kPa)
Pressure connection	Standard: p+ Optional: p+	G 1/4 female thread on centre of housing underside as per ISO 228: Gas or air additionally G 1/4 female thread on opposite measuring connection side: gas or air
Measuring connectio	Test nipple integrated in metal housing, \varnothing 9	
Temperature range	Ambient temperature Medium temperature Storage temperature	-15 °C bis +70 °C -15 °C bis +70 °C -30 °C bis +80 °C
Materials	Housing base: Hood: Switch: Diaphragms: Switching contact:	aluminum die casting Polycarbonate Polycarbonate NBR Standard: Ag Optional: Ag gold-plated (Au), suitable for DDC applications: 24 VDC; 0.02 A
Switching voltage	Ag contact Au contact	AC eff. min. 10 V max. 250 V DC min. 12 V max. 48 V DC min. 5 V max. 24 V
Nominal current	Ag contact Au contact	AC eff. 10 A DC 20 mA
Switching current	Ag contact Au contact	AC eff. min. 20 mA max. 6 A as $\cos \varphi$ 1 DC min. 24 mA max. 3 A as $\cos \varphi$ 0,6 DC min. 20 mA max. 1 A DC min. 5 mA max. 20 mA
Electrical connection	Standard: Special design:	at screw terminals via PG11 cable gland plug connection for line sockets as per DIN EN 175 301-803, 3-pin with protective contact
Degree of protection	IP 54 as per IEC 529 (EN 60529)	
Adjustment	In a vertical position NB...A4: As pressure falls ÜB...A4: As pressure rises If installation position deviates, note change in switching point	
Setting tolerance	$\pm 15\%$ switching point deviation based on the setpoint and with unit installed in a vertical position	
Deviation	Permissible deviation of the set value $\leq \pm 15\%$ in the service life test according to EN 1854	

Dimensions [mm]

ÜB ... A4, NB ... A4

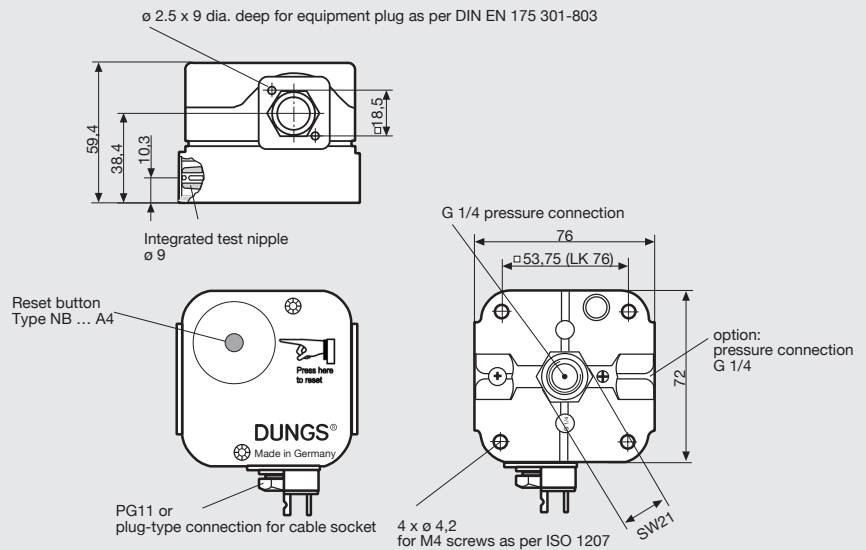

SW = Wrench width

Installation position

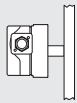

Standard installation position, if a different installation position is used, pay attention to the changed operating points



When installed horizontally, the pressure switch switches at a pressure higher by approx. 0.5 mbar.



When installed horizontally overhead, the pressure switch switches at a pressure lower by approx. 0.5 mbar.

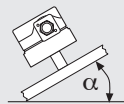

When installed in an intermediate installation position, the pressure switch switches at pressure deviating from the set reference value by max. ± 0.5 mbar.

Designation

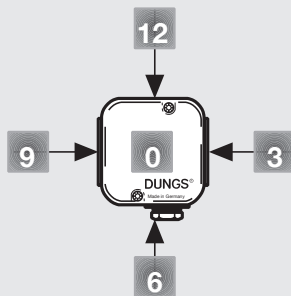

Order example

Pressure switch design

ÜB pressure limiter

Setting range

30 - 150 mbar

Contact material

Ag

Electrical connection

Cable gland PG11

Test nipple

MS 9

Pressure connection G1/4

V0-VS3: an Position 0 and Position 3 with screw plug

ÜB 150 A4 [Ag-PG-MS9-V0-VS3]

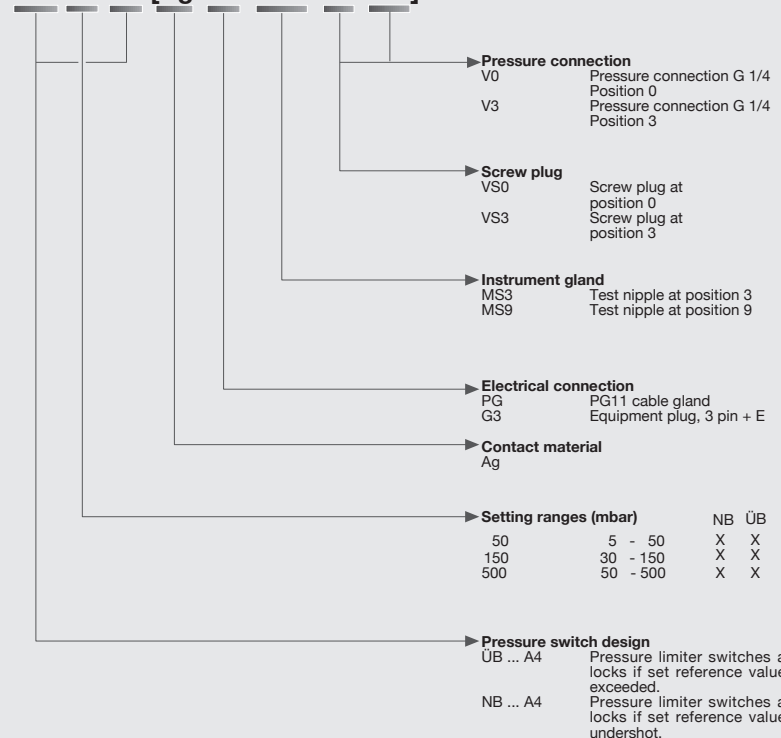

ÜB 150 A4 [Ag-PG-MS9-V0-VS3]



**Pressure limiter
ÜB...A4 and NB...A4**



Technical data 1 mbar = 100 Pa = 0,1 kPa ≈ 10 mm WS 1 Pa = 0,01 mbar ≈ 0,1 mm WS

Type	Version Glow lamp ~ (AC) 230 V [Ag-PG-MS9-V0]	Order No. 1 piece	Setting range		Switching difference [mbar]	Degree of pro- tection
			[mbar]	max.		
ÜB...A4 pressure limiter	ÜB 50 A4	210 537	5 - 50	± 15 %		IP 54
	ÜB 150 A4	138 630	30 - 150	± 15 %		
	ÜB 500 A4	210 970	50 - 500	± 15 %		
	[Ag-PG-MS9-V0]	1 Stück	[mbar]	max.	[mbar]	
NB...A4 pressure limiter	NB 50 A4	210 534	5 - 50	± 15 %		IP 54
	NB 150 A4	210 931	30 - 150	± 15 %		
	NB 500 A4	210 971	50 - 500	± 15 %		

Accessories for pressure switches NB...A4, ÜB...A4	Order No.
Kit: G3 equipment plug, 3-pin + E, NB/ÜB A2/A4	227 644
Line socket, 3-pin + E grey GDMW	210 318
Glow lamp yellow, (1 x) ~(AC) 230 V (spare part requirement NB , ÜB)	266 039
Glow lamp yellow, (1 x) ~(AC) 120 V (spare part requirement NB , ÜB)	244 156
Signal lamp LED yellow, 24 V AC/DC (1 x)	244 157
G 1/4 test nipple and seal ring (1 x)	266 042
G 1/4 screw plug and seal ring	266 044
Metal mounting bracket	230 288
Mounting Kit Double Pressure Switch	213 910
Cheese head screw ø 3x14 (2 x)	266 045

We reserve the right to make any changes in the interest of technical progress.

Head Offices and Factory
Karl Dungs GmbH & Co. KG
Karl-Dungs-Platz 1
D-73660 Urbach, Germany
Telephone +49 (0)7181-804-0
Fax +49 (0)7181-804-166

Postal address
Karl Dungs GmbH & Co. KG
Postfach 12 29
D-73602 Schorndorf, Germany
e-mail info@dungs.com
Internet www.dungs.com